

UP-Einhandbatterie mit integriertem Brauseanschluss mit Duschgarnitur -
Chrom

TARA

ST 050 205 6660



Passt zu: TARA, META

- Abdeckplatte Ø 78 mm
 - Metallbrauseschlauch 1750 mm mit integriertem Verdrehenschutz
 - Wandrohr mit Schieber
 - Dreifach bzw. fünffach verstellbar: COMPACT RAIN, COMPACT SOFT FLOW, COMPACT AQUAPRESSURE FLOW, Durchfluss max. l/min (bei 3 Bar)
 - Brausekopf Ø 100 mm
- Eigensicher gegen Rückfließen.**

	Chrom	ST 050 205 6660-00
	Platin gebürstet	ST 050 205 6660-06
	Platin	ST 050 205 6660-08
	Dark Chrome	ST 050 205 6660-19
	Messing gebürstet (23kt Gold)	ST 050 205 6660-28
	Schwarz matt	ST 050 205 6660-33
	Bronze gebürstet	ST 050 205 6660-42
	Champagne gebürstet (22kt Gold)	ST 050 205 6660-46
	Champagne (22kt Gold)	ST 050 205 6660-47
	Chrom gebürstet	ST 050 205 6660-93
	Dark Platinum gebürstet	ST 050 205 6660-99

Einzelkomponenten dieses Sets

Für dieses Set benötigen Sie folgende Komponenten

1x 28 018 979-00



1x 36 013 660-00



**UP-Einhandbatterie mit integriertem Brauseanschluss mit Duschgarnitur -
Chrom**

TARA





























ST 050 205 6660



- Dreifach bzw. fünffach verstellbar: COMPACT RAIN, COMPACT SOFT FLOW, COMPACT AQUAPRESSURE FLOW, Durchfluss max. 15 l/min (bei 3 Bar)
- mit Antikalk-System
- Brausekopf Ø 100 mm
- Anschluss 1/2"
- Funktion ab: 7 l/min

Eigensicher gegen Rückfließen.

Passt zu: IMO, LULU, MADISON, MEM, TARA, CL.1, LISSÉ, VAIA, META, CYO

	Chrom	28 018 979-00
	Chrom	28 018 979-00 0010
	Platin gebürstet	28 018 979-06
	Platin gebürstet	28 018 979-06 0010
	Platin	28 018 979-08
	Platin	28 018 979-08 0010
	Dark Brass matt	28 018 979-16 0010
	Dark Bronze matt	28 018 979-17 0010
	Dark Chrome	28 018 979-19
	Dark Chrome	28 018 979-19 0010
	Light Gold	28 018 979-26 0010
	Light Gold	28 018 979-26
	Light Gold gebürstet	28 018 979-27 0010
	Light Gold gebürstet	28 018 979-27
	Messing gebürstet (23kt Gold)	28 018 979-28
	Messing gebürstet (23kt Gold)	28 018 979-28 0010
	Schwarz matt	28 018 979-33
	Schwarz matt	28 018 979-33 0010
	Bronze gebürstet	28 018 979-42
	Bronze gebürstet	28 018 979-42 0010
	Champagne gebürstet (22kt Gold)	28 018 979-46
	Champagne gebürstet (22kt Gold)	28 018 979-46 0010
	Champagne (22kt Gold)	28 018 979-47
	Champagne (22kt Gold)	28 018 979-47 0010
	Chrom gebürstet	28 018 979-93
	Chrom gebürstet	28 018 979-93 0010
	Dark Platinum gebürstet	28 018 979-99
	Dark Platinum gebürstet	28 018 979-99 0010

ST 050 205 6660
mm [inches]

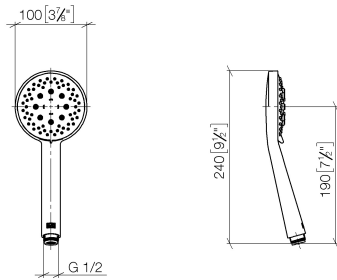

Durchflussdiagramm

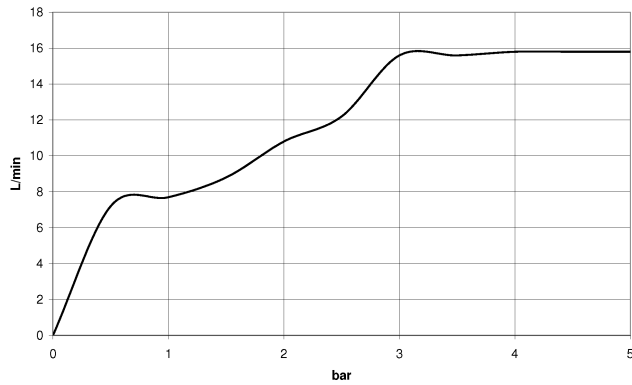

Zertifikate

LGA_29984.

DVGW_DW-
6517DN0129.

WRAS_2210003.

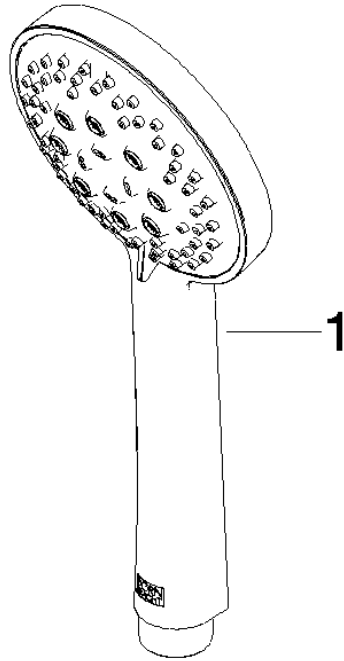

Ersatzteilstückliste

Nr.	Artikelnummer	Benennung	Verbaumenge	Lieferzeit
1	09 23 01 039 90	Sieb	1	2

**UP-Einhandbatterie mit integriertem Brauseanschluss mit Duschgarnitur -
Chrom**

TARA

ST 050 205 6660



Passt zu: TARA, META

- Abdeckplatte Ø 78 mm
- Metallbrauseschlauch 1750 mm mit integriertem Verdrehschutz
- Wandrohr mit Schieber

Dieser Artikel enthält keine Handbrause!

Eigensicher gegen Rückfließen.

Artikel nicht verlängerbar, bitte unbedingt Einbautiefe beachten!

Dieser Artikel enthält keine Handbrause!

Eigensicher gegen Rückfließen.

Artikel nicht verlängerbar, bitte unbedingt Einbautiefe beachten!

	Chrom	36 013 660-00
	Platin gebürstet	36 013 660-06
	Platin	36 013 660-08
	Dark Chrome	36 013 660-19
	Light Gold gebürstet	36 013 660-27
	Messing gebürstet (23kt Gold)	36 013 660-28
	Schwarz matt	36 013 660-33
	Champagne gebürstet (22kt Gold)	36 013 660-46
	Champagne (22kt Gold)	36 013 660-47
	Chrom gebürstet	36 013 660-93
	Dark Platin gebürstet	36 013 660-99

Benötigtes Zubehör

	UP-Wandbefestigung - •Max. Einbautiefe 103 mm •Min. Einbautiefe 78 mm	35 003 970 90
---	--	---------------

Benötigtes Zubehör

	Handbrause - Chrom	28 012 979-00
---	---------------------------	---------------

Benötigtes Zubehör

	Handbrause - Chrom	28 017 979-00
---	---------------------------	---------------

Benötigtes Zubehör

	Handbrause - Chrom	28 018 979-00
---	---------------------------	---------------

Benötigtes Zubehör

	Handbrause - Chrom	28 016 979-00
---	---------------------------	---------------

Benötigtes Zubehör

	Handbrause FlowReduce - Chrom	28 016 979-00 0010
---	--------------------------------------	-----------------------

Benötigtes Zubehör

	Handbrause FlowReduce - Chrom	28 012 979-00 0010
---	--------------------------------------	-----------------------

Benötigtes Zubehör

	Handbrause FlowReduce - Chrom	28 018 979-00 0010
---	--------------------------------------	-----------------------

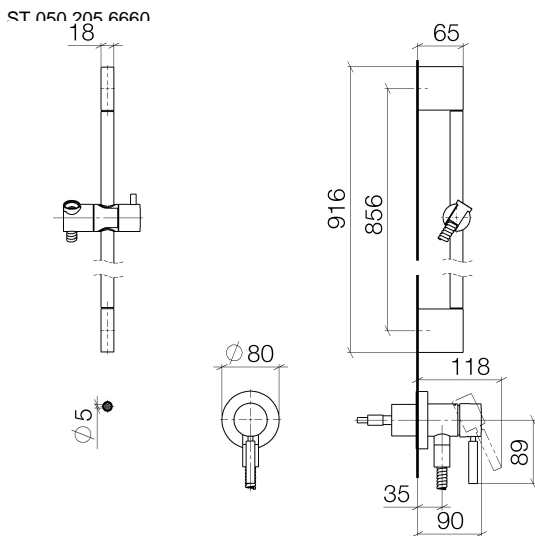

Zertifikate

Belgaqua_21-025- WRAS_2011027. LGA_29569.
27_1.

ST 050 205 6660

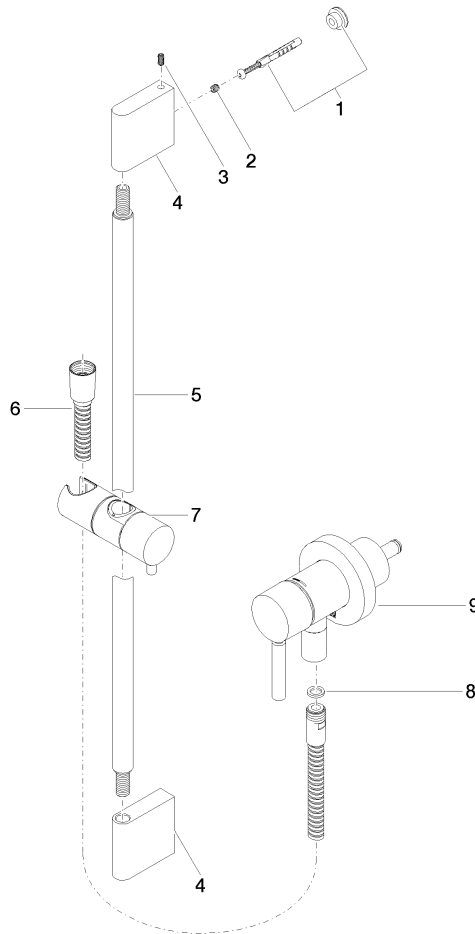

Ersatzteilstückliste

Nr.	Artikelnummer	Benennung	Verbaumenge	Lieferzeit
1	05 17 20 726 02 90	Befestigungssatz	1	2
2	09 31 11 049 90	Stift	2	2
3	04 31 11 113 00 90	Stift	2	2
4	08 17 97 054-00	Halter	2	10
5	90 28 22 597 00-00	Halter	1	10
6	28 322 970-00	Metall-Brauseschlauch 1/2" x 3/8" x 1750 mm - Chrom	1	2
7	12 580 970-00	Schieber - Chrom	1	10
8	90 14 20 026 00 90	Dichtung	1	2
9	36 045 660-00	UP-Einhandbatterie mit Abdeckplatte mit integriertem Brauseanschluss - Chrom	1	10